

Collimation of Astigmatic Diode Laser Beam by Objective Lens

Abstract

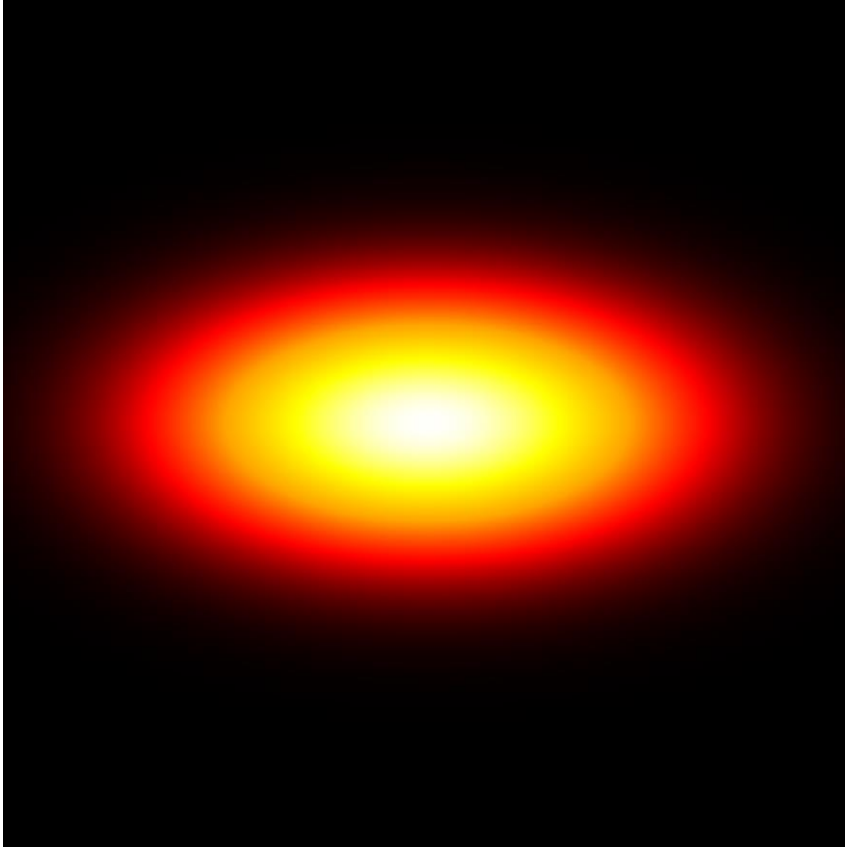

Laser diodes are one of the most commonly used sources nowadays. High-power laser diodes often exhibit asymmetric divergence in two directions. They must be collimated in most applications. In addition to the divergence, such sources may also show astigmatism between two directions. In this example, collimation of an astigmatic laser diode is investigated with both ray tracing and field tracing techniques, and it is compared with a reference case without astigmatism.

Modeling Task

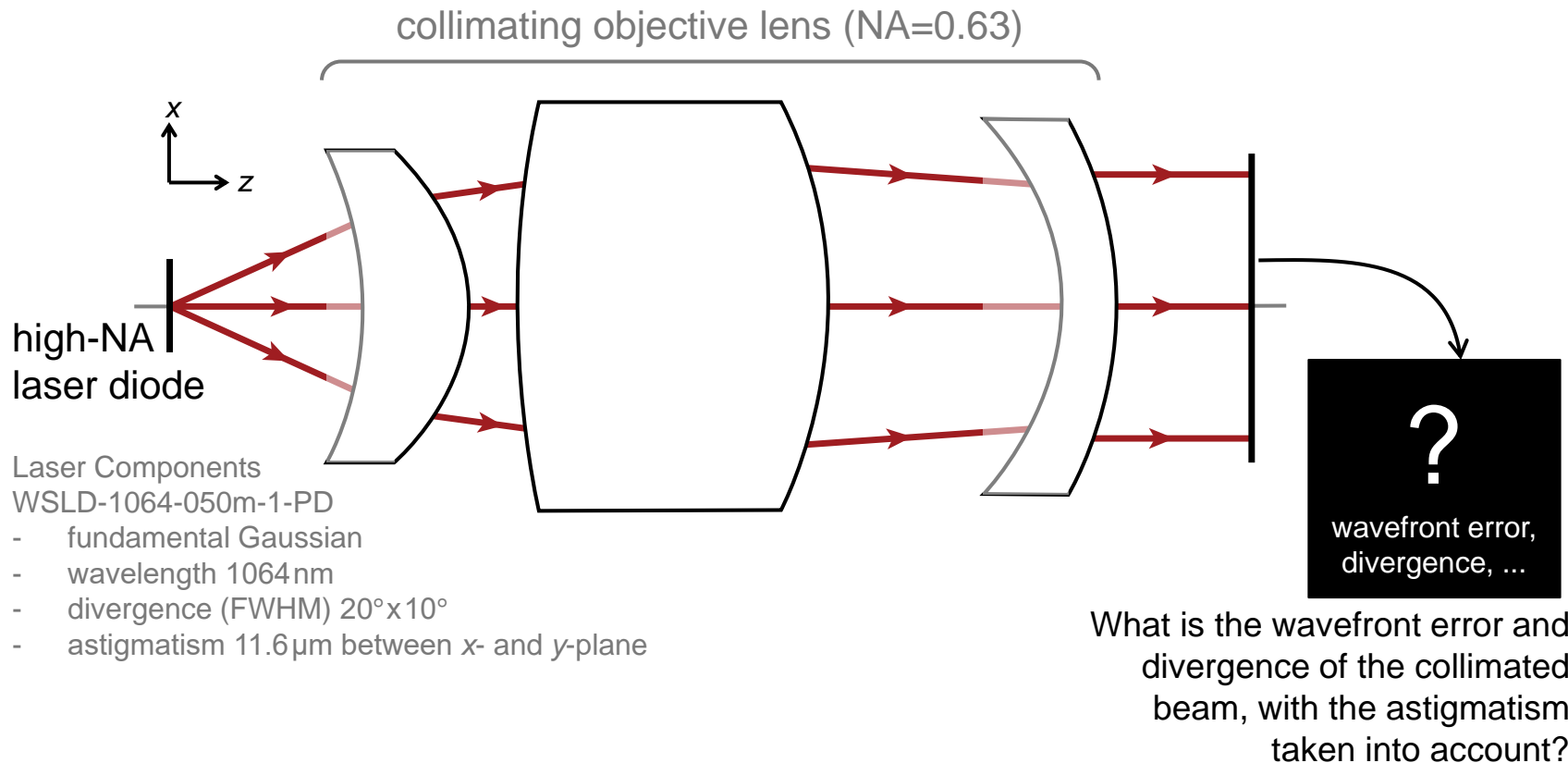

Results

- Ray tracing – system in 3D space

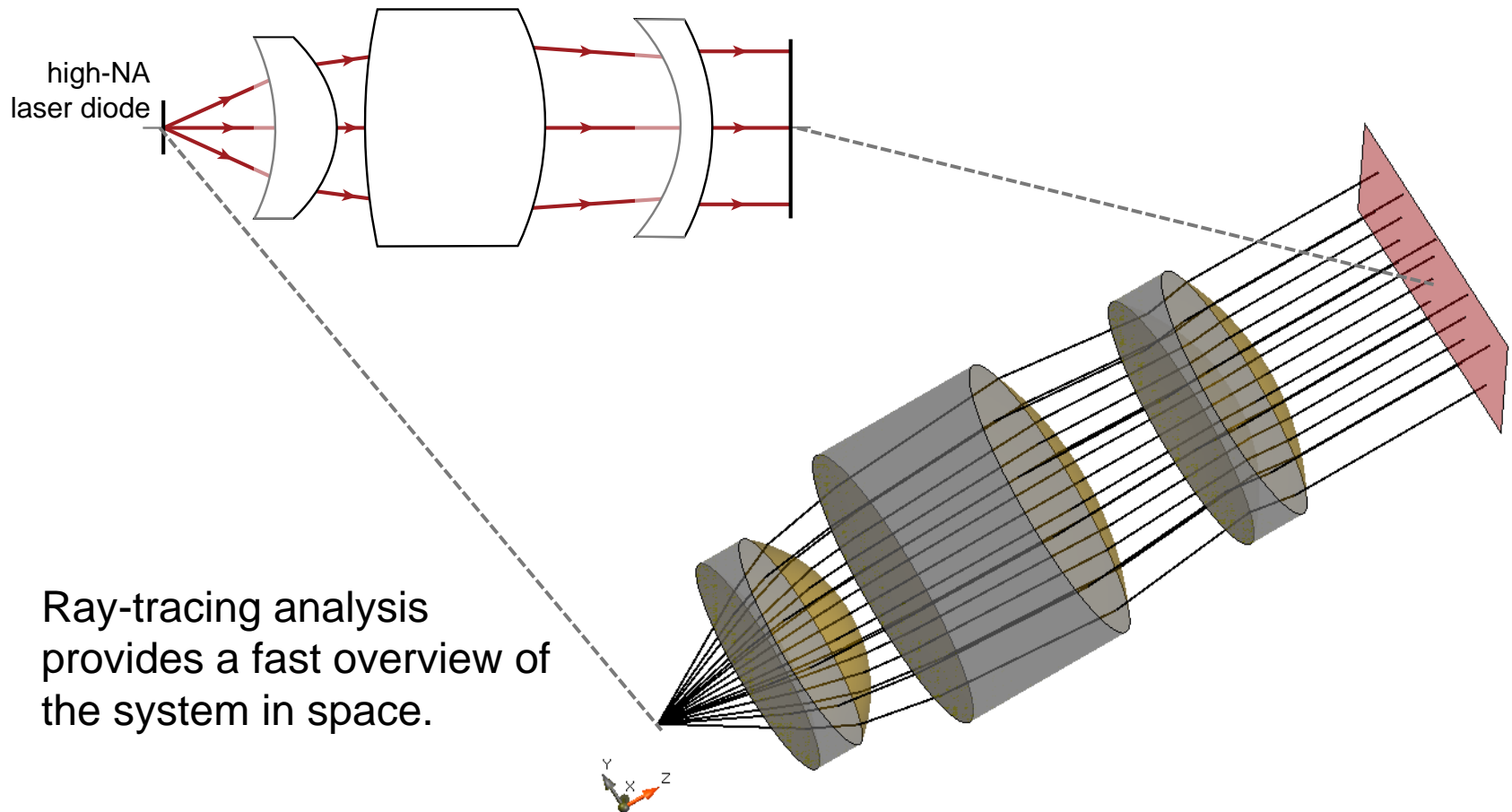

Results

- Ray tracing – wavefront analysis

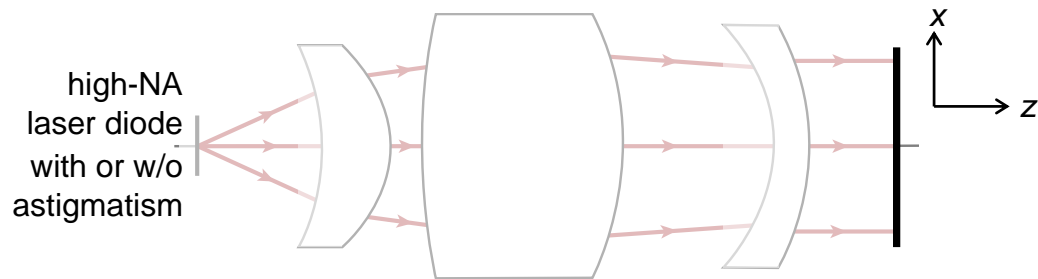

Laser diode properties, including astigmatism, are taken into account for the ray-tracing simulation.

Wavefront error	With astigmatism	Without astigmatism
P-V	2.896λ	0.089λ
RMS	0.704λ	0.026λ

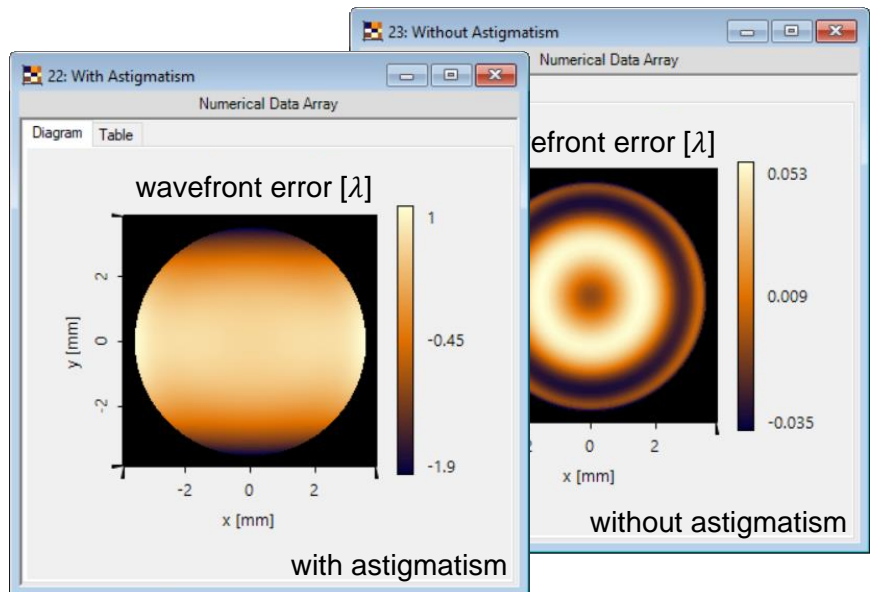

Results

- Field tracing – divergence and beam quality

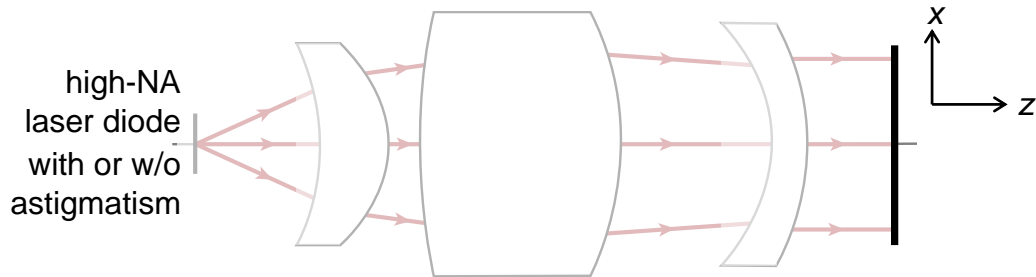

Physical-optics simulation of whole collimation system takes less than 2 second!

Multiple physical parameters are available for quantitative evaluations.

Parameters	With astigmatism	Without astigmatism
div. angle (x)	0.024°	0.024°
div. angle (y)	0.051°	0.043°
M^2 (x)	1.061	1.090
M^2 (y)	1.009	1.007

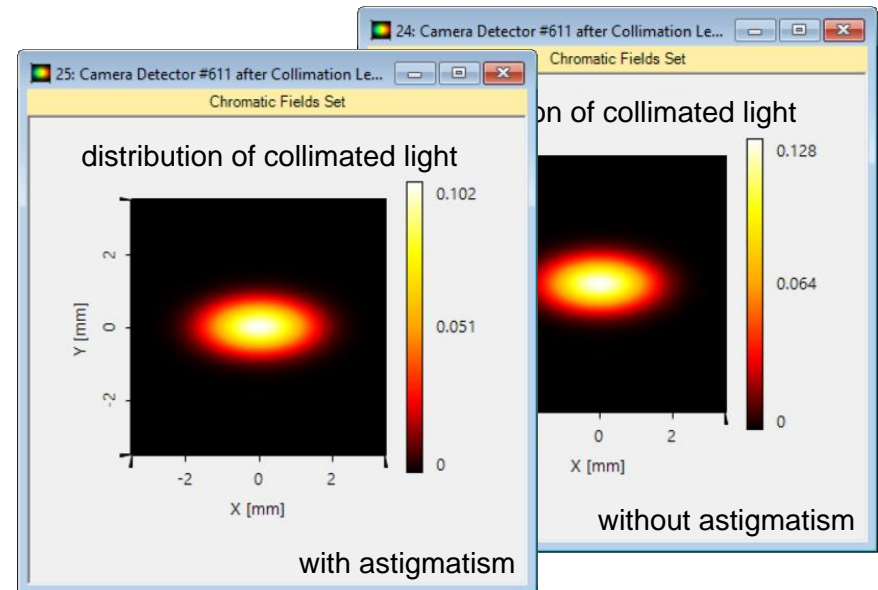

Document Information

title	Collimation of Astigmatic Diode Laser Beam by Objective Lens
version	1.0
VL version used for simulations	7.0.3.4
category	Application Use Case
